

SmallEiffel -0.74
Partial "tools" class diagram

Cyril ADRIAN, 2002

Edited with ArgoUML 0.9.9
<http://www.argouml.org>

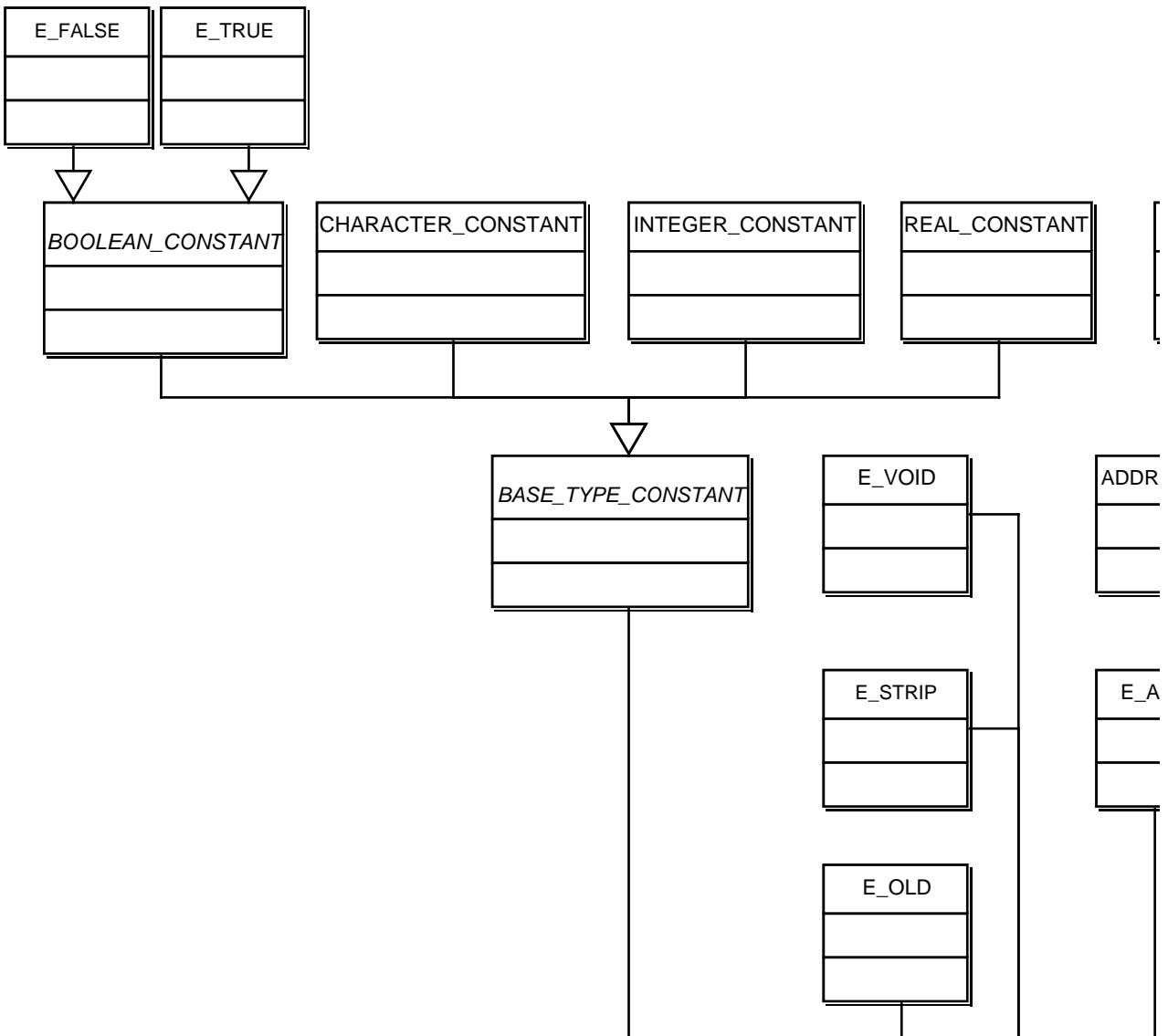

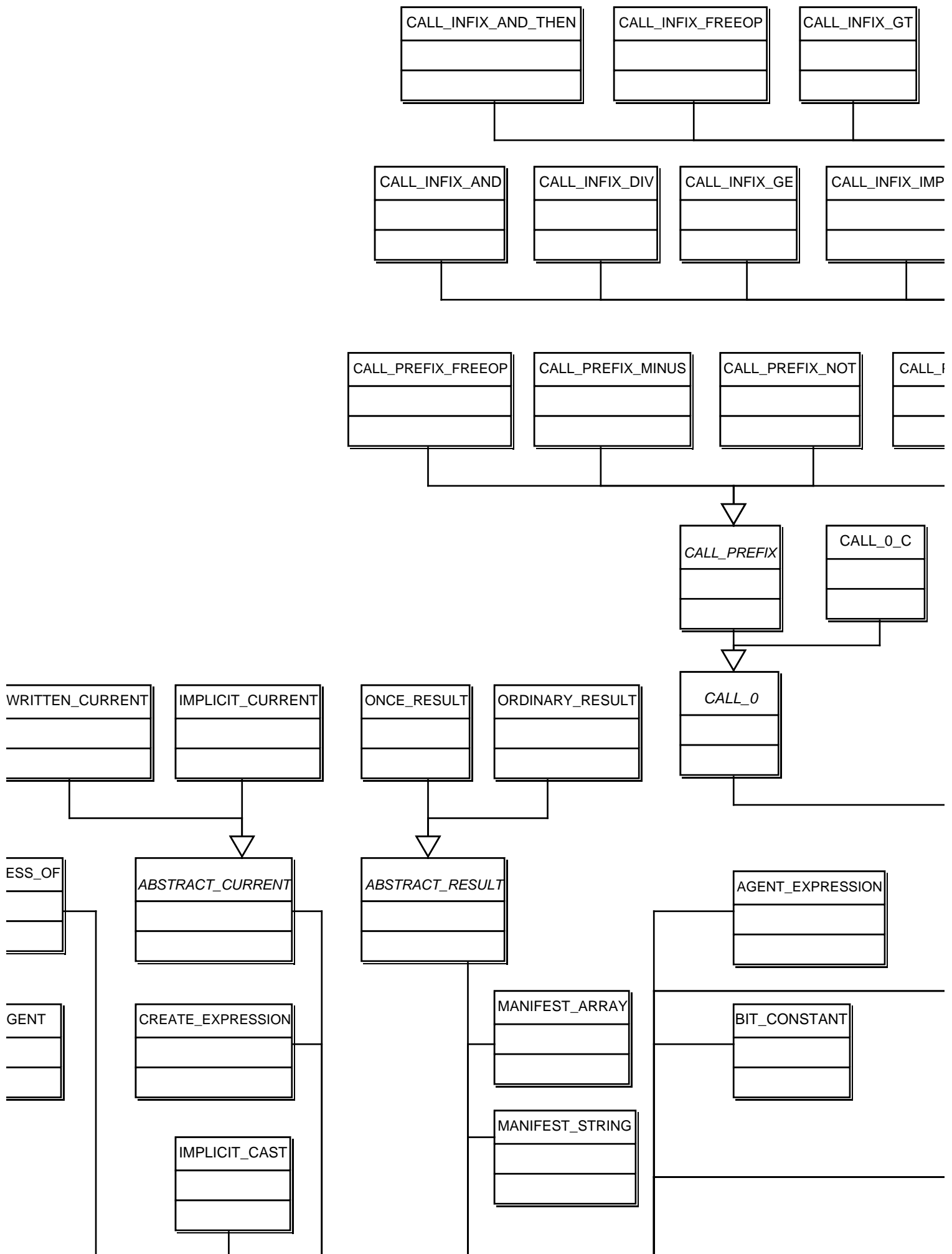

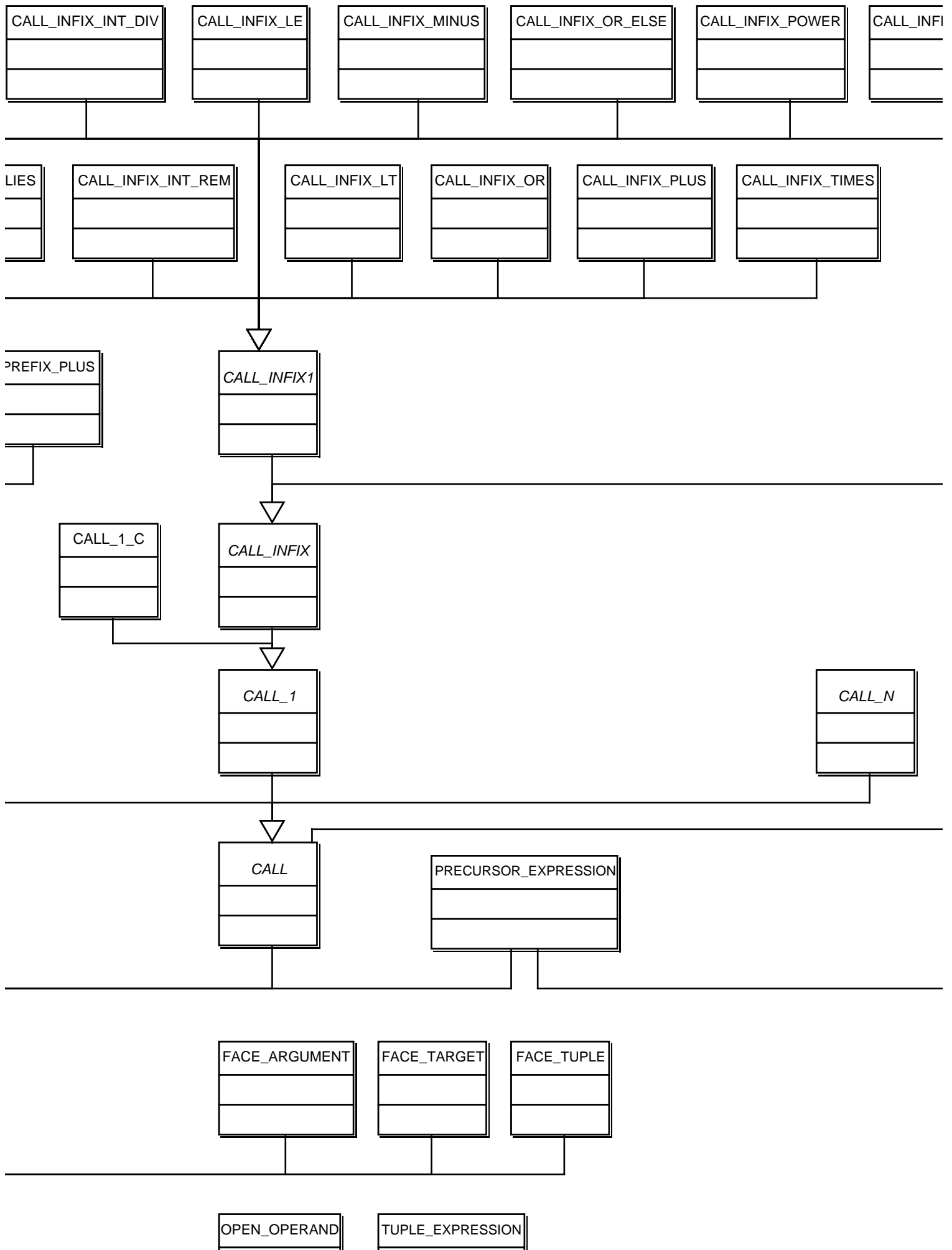

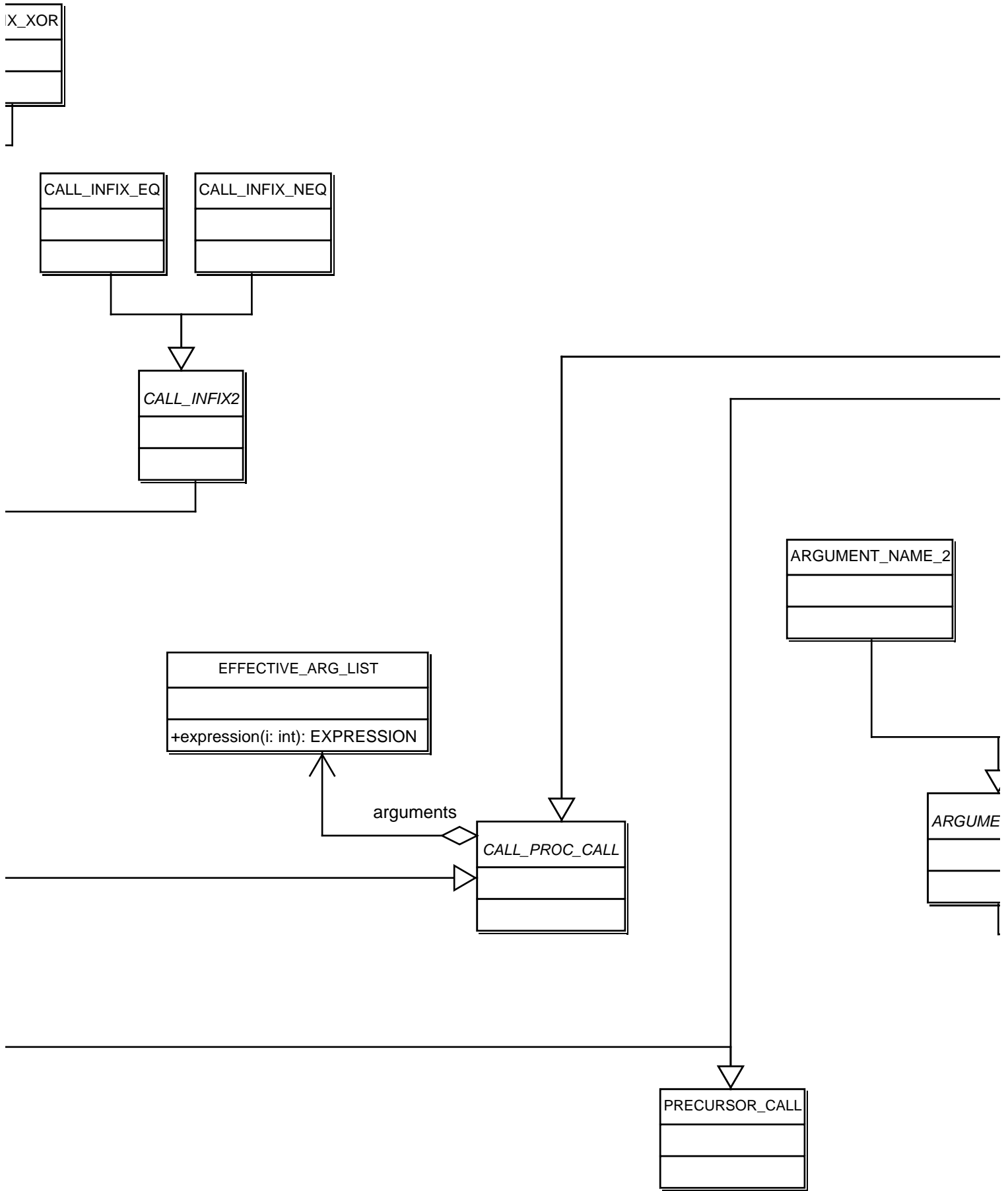

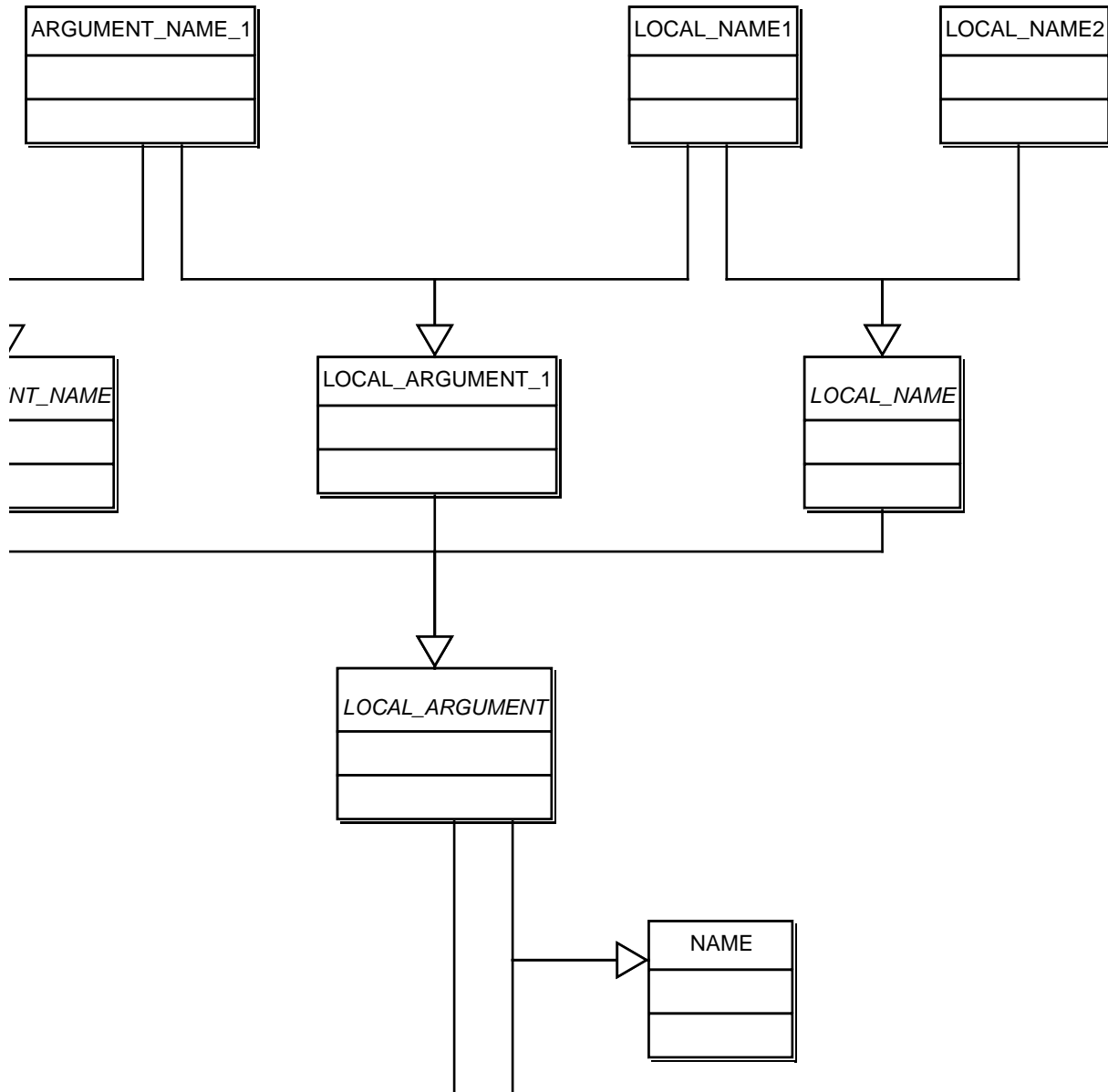

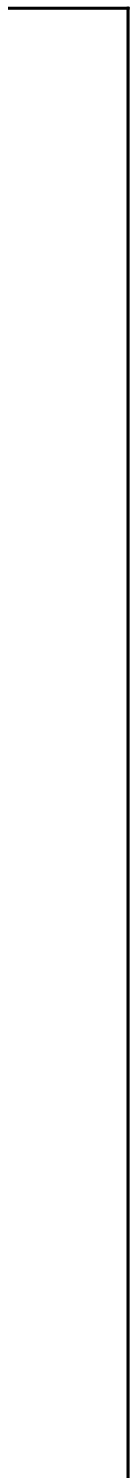

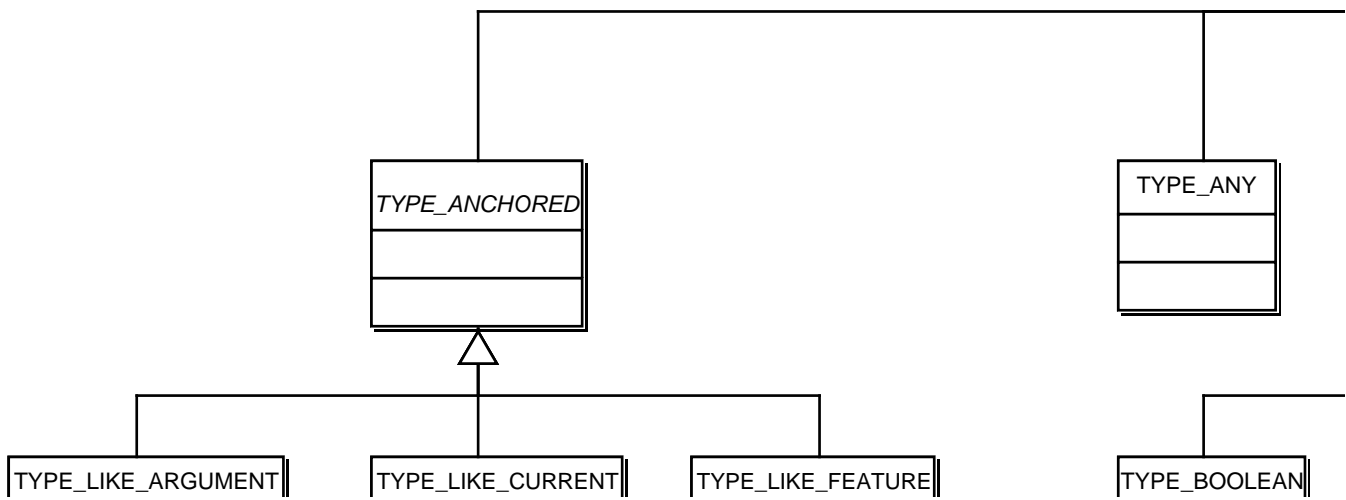

--	--	--

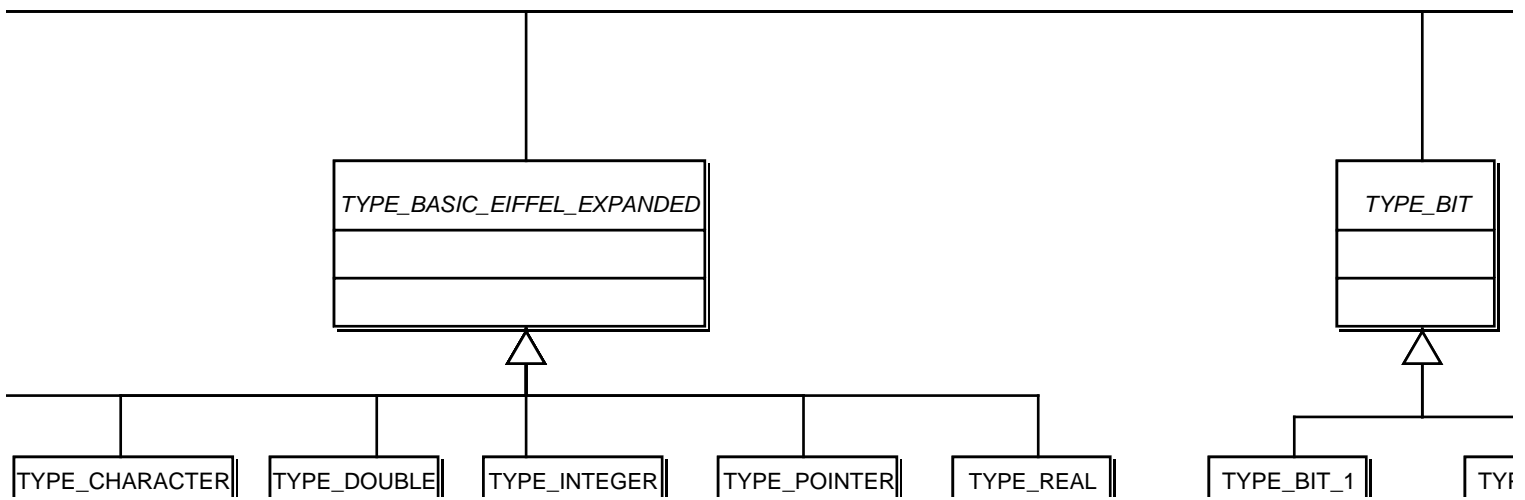

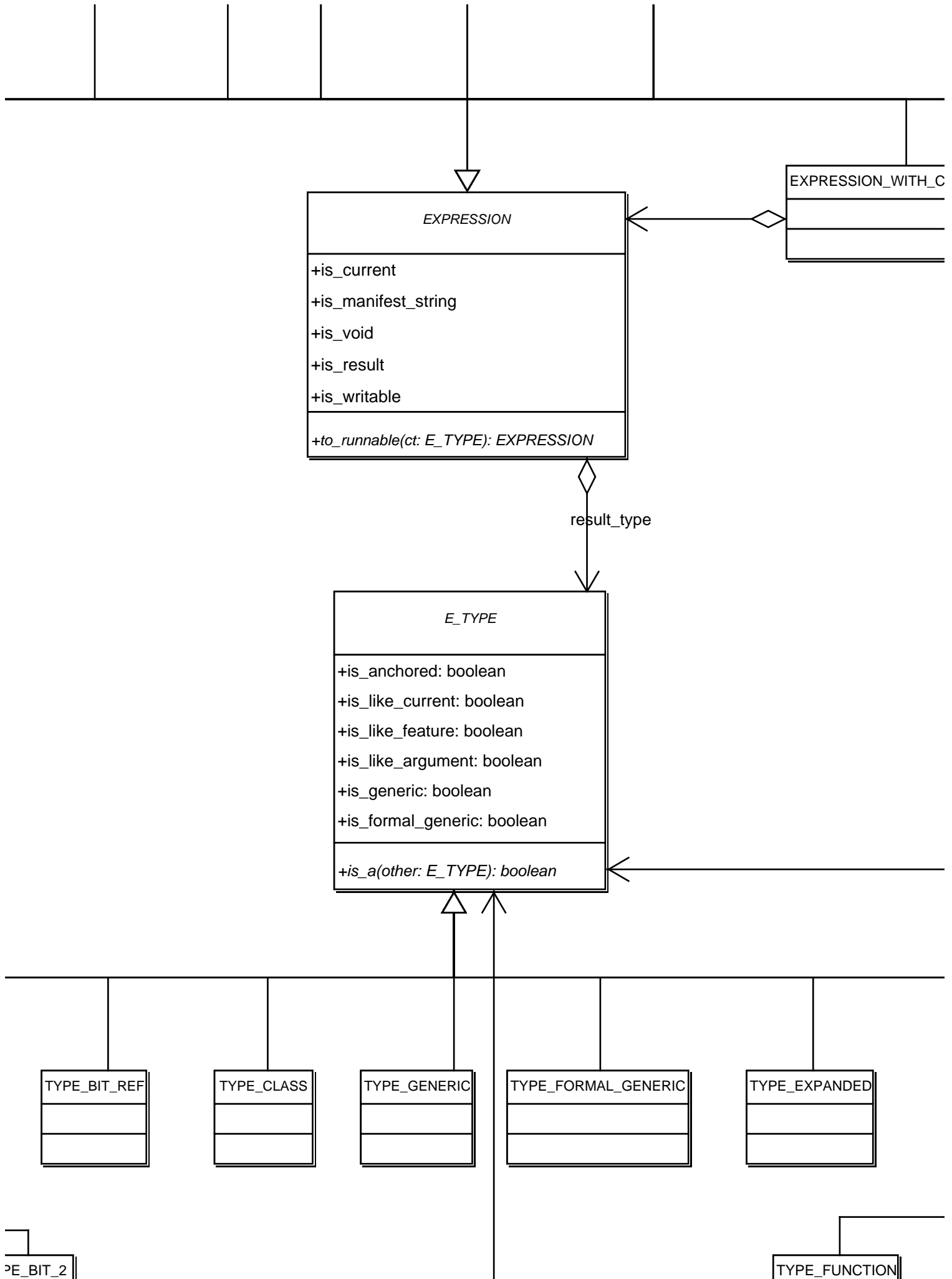

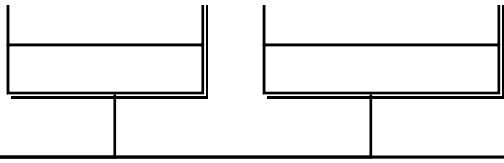

COMMENT

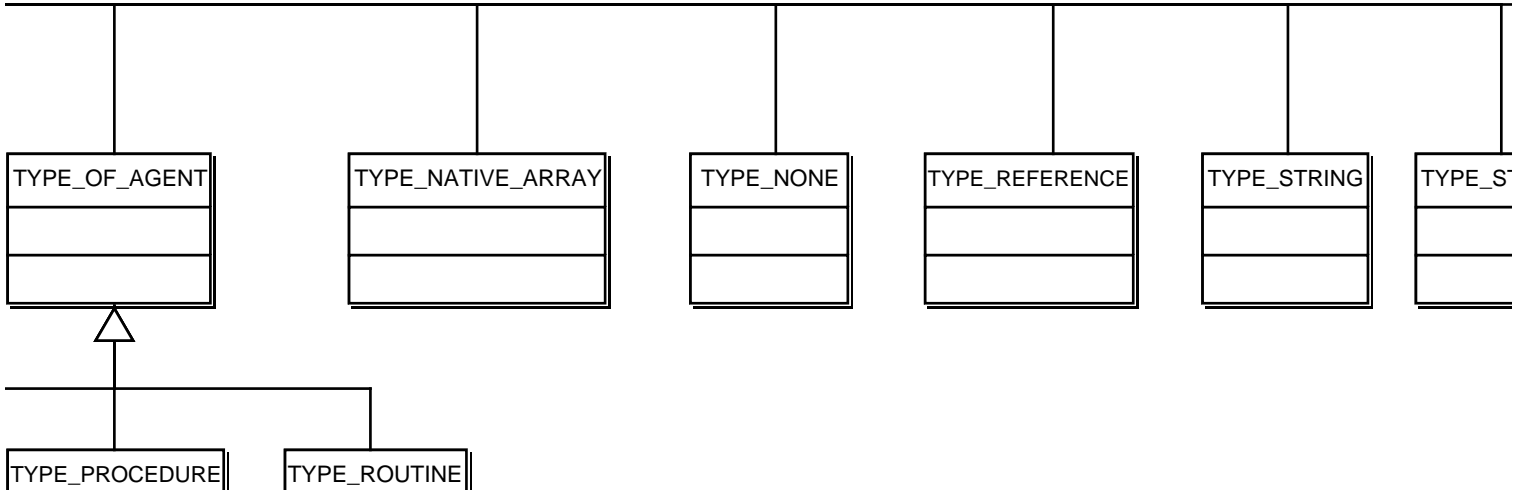

class diagram 1

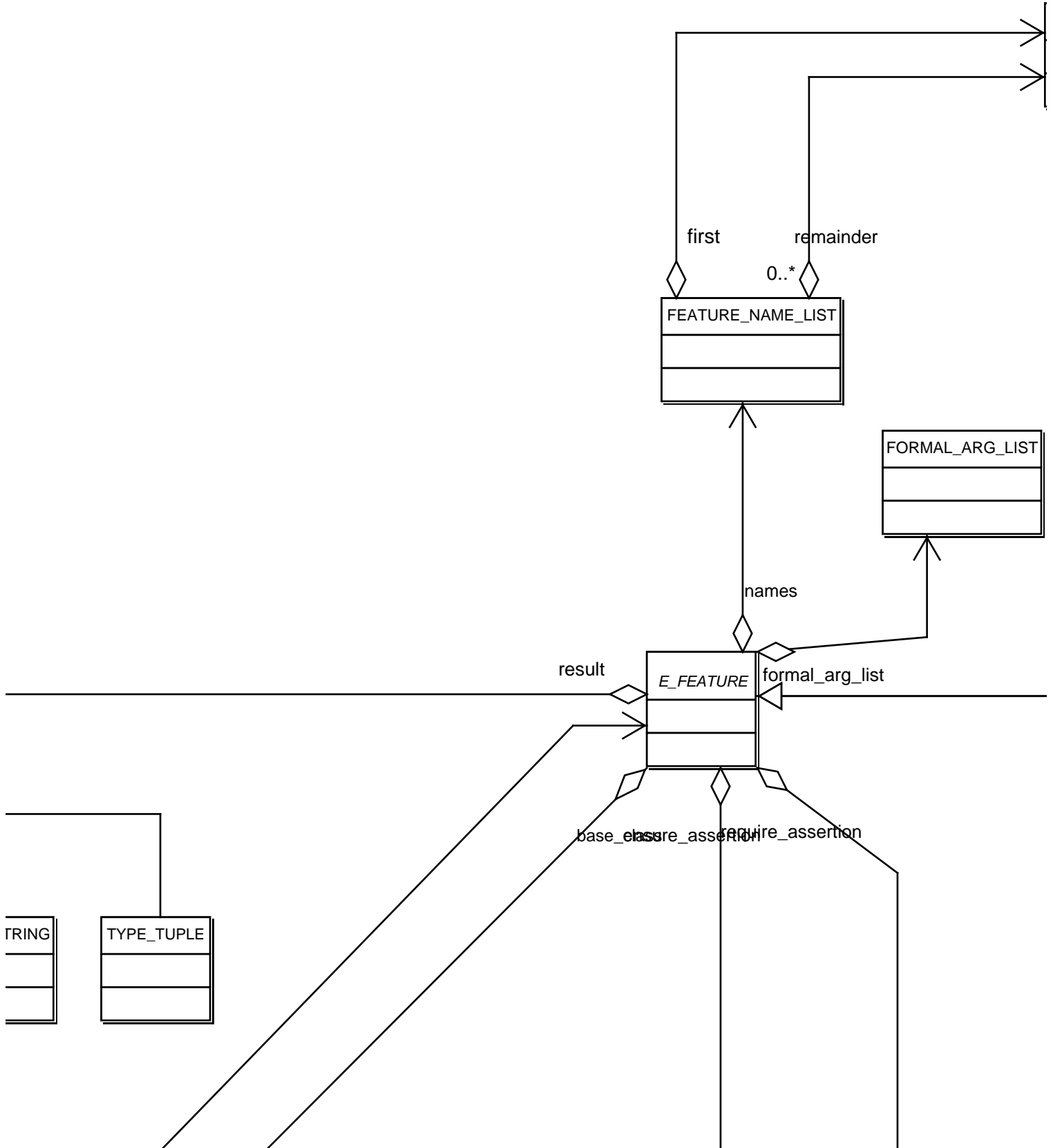

class diagram 1

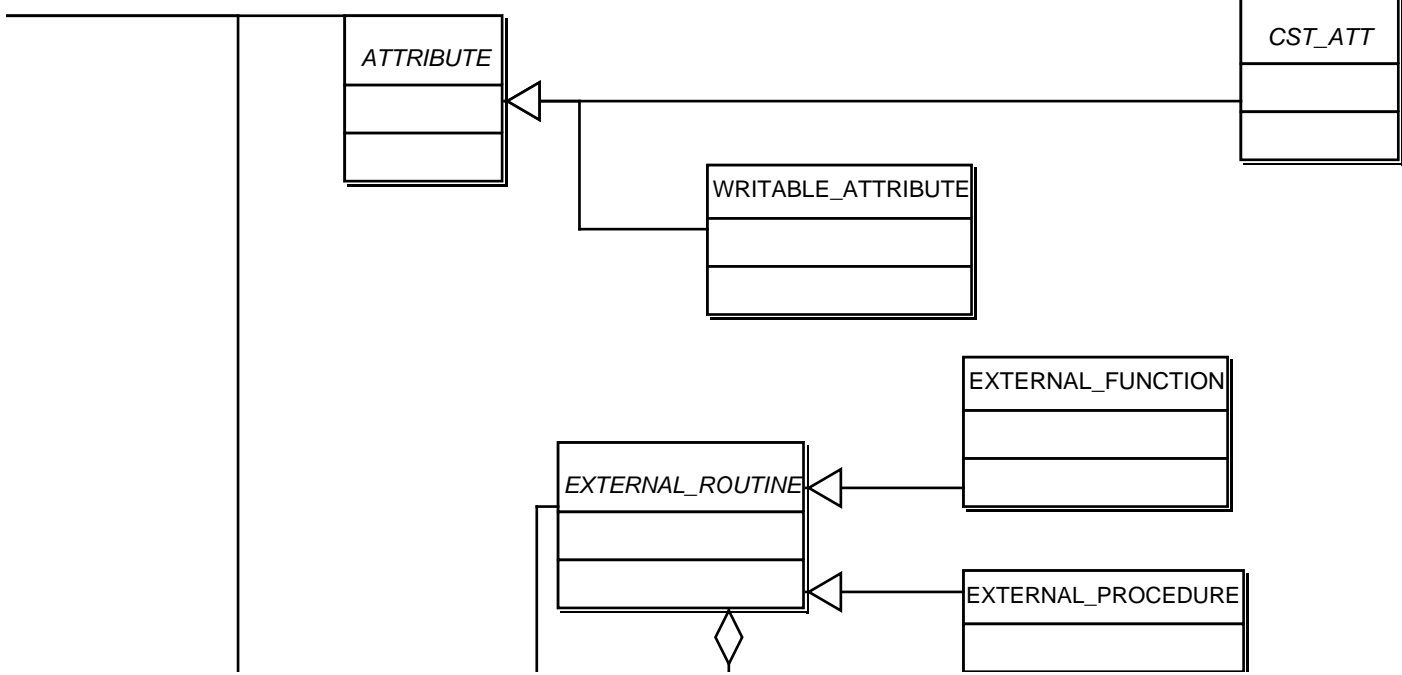
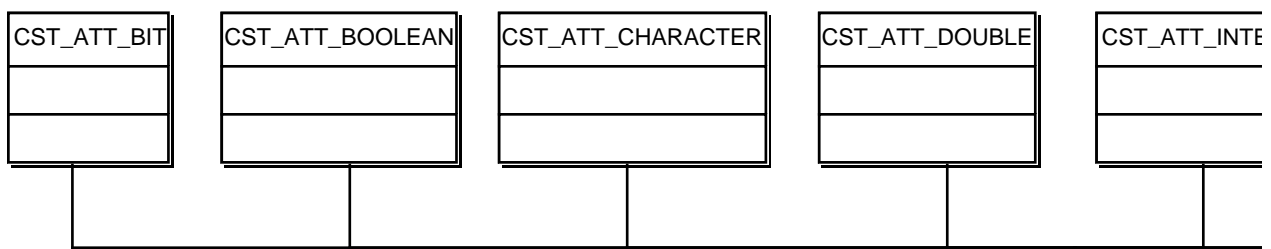
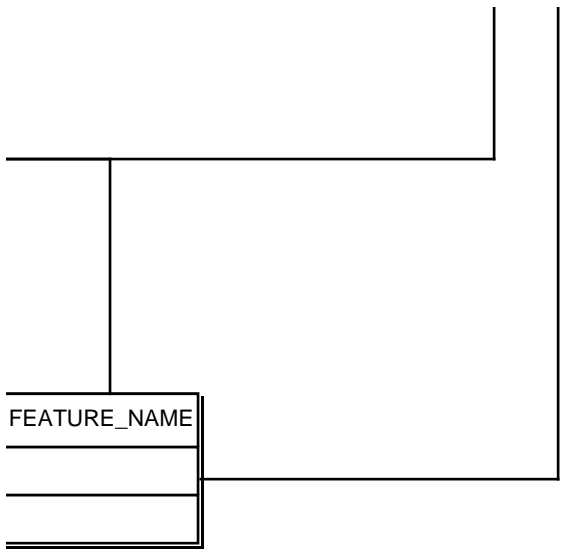

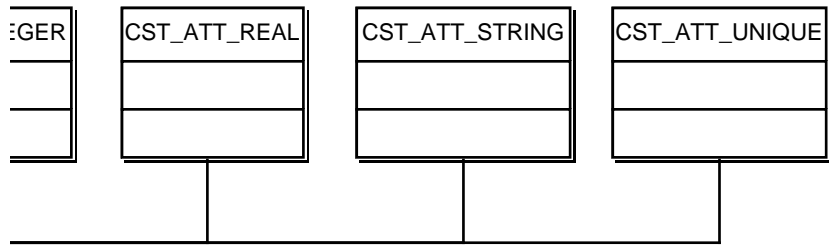

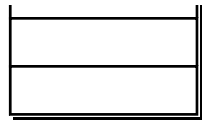
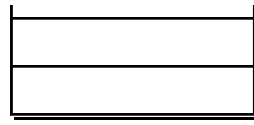
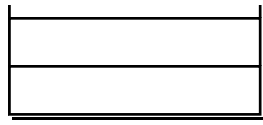
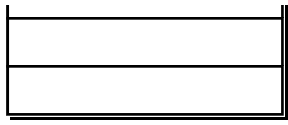

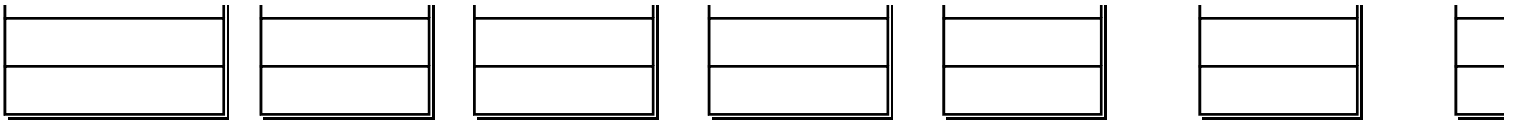

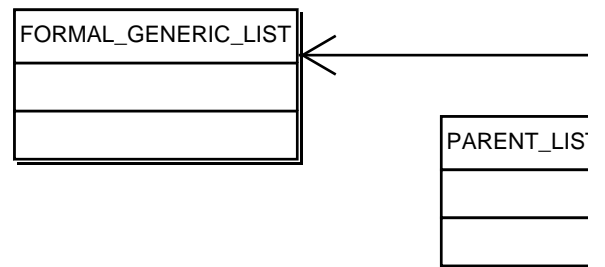
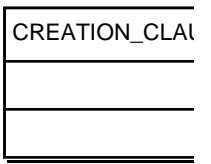
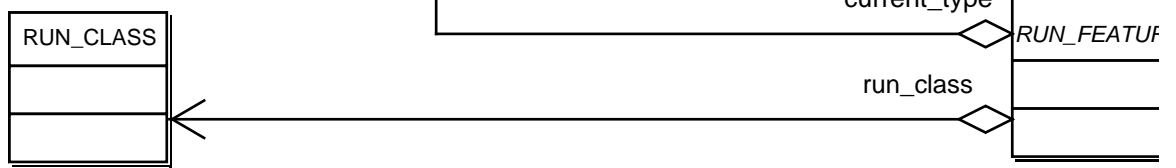
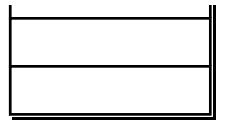
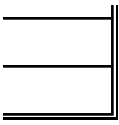

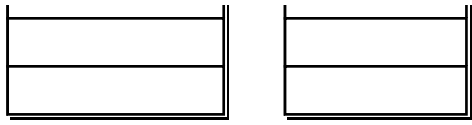

RE

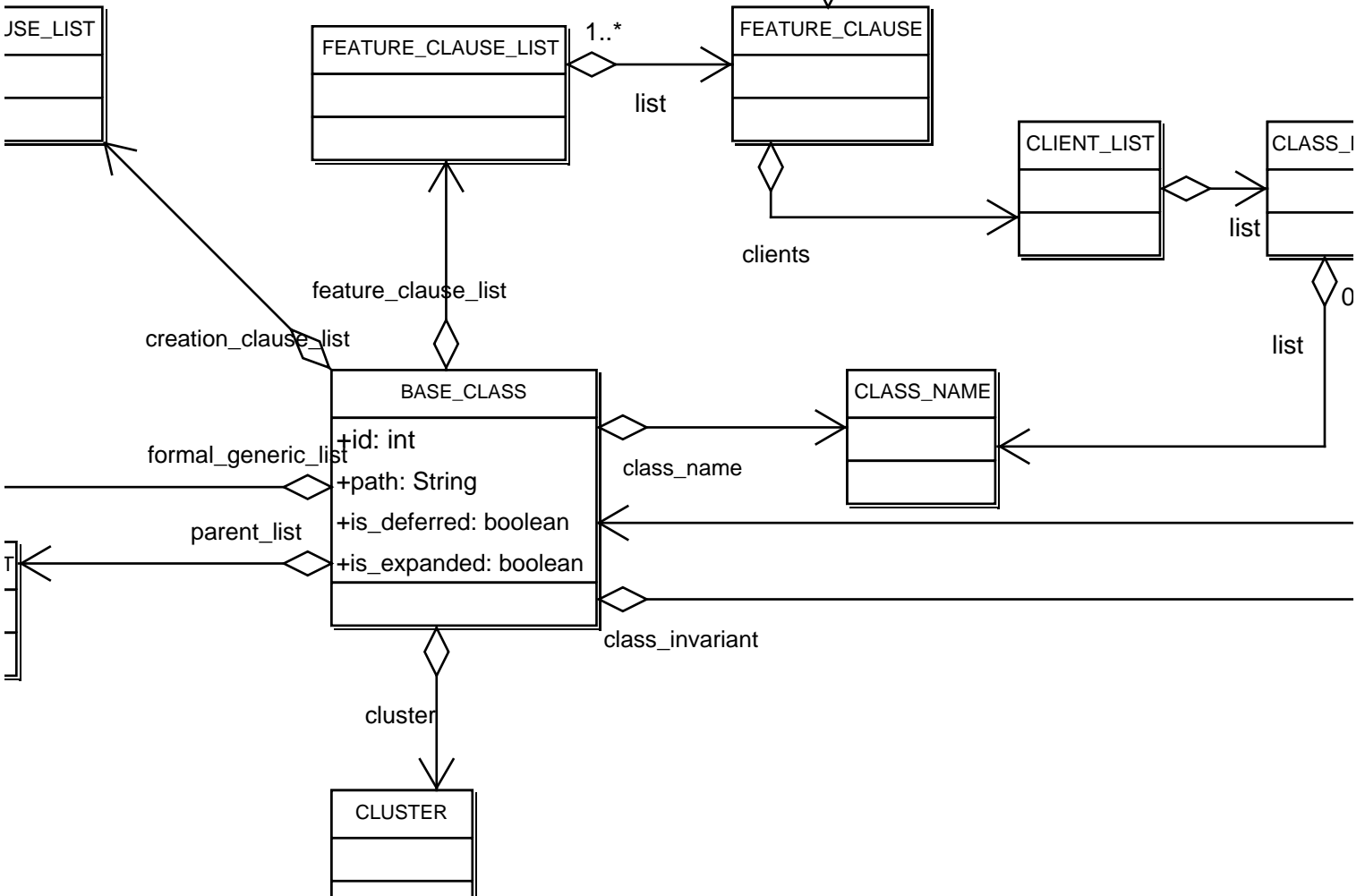

class diagram 1

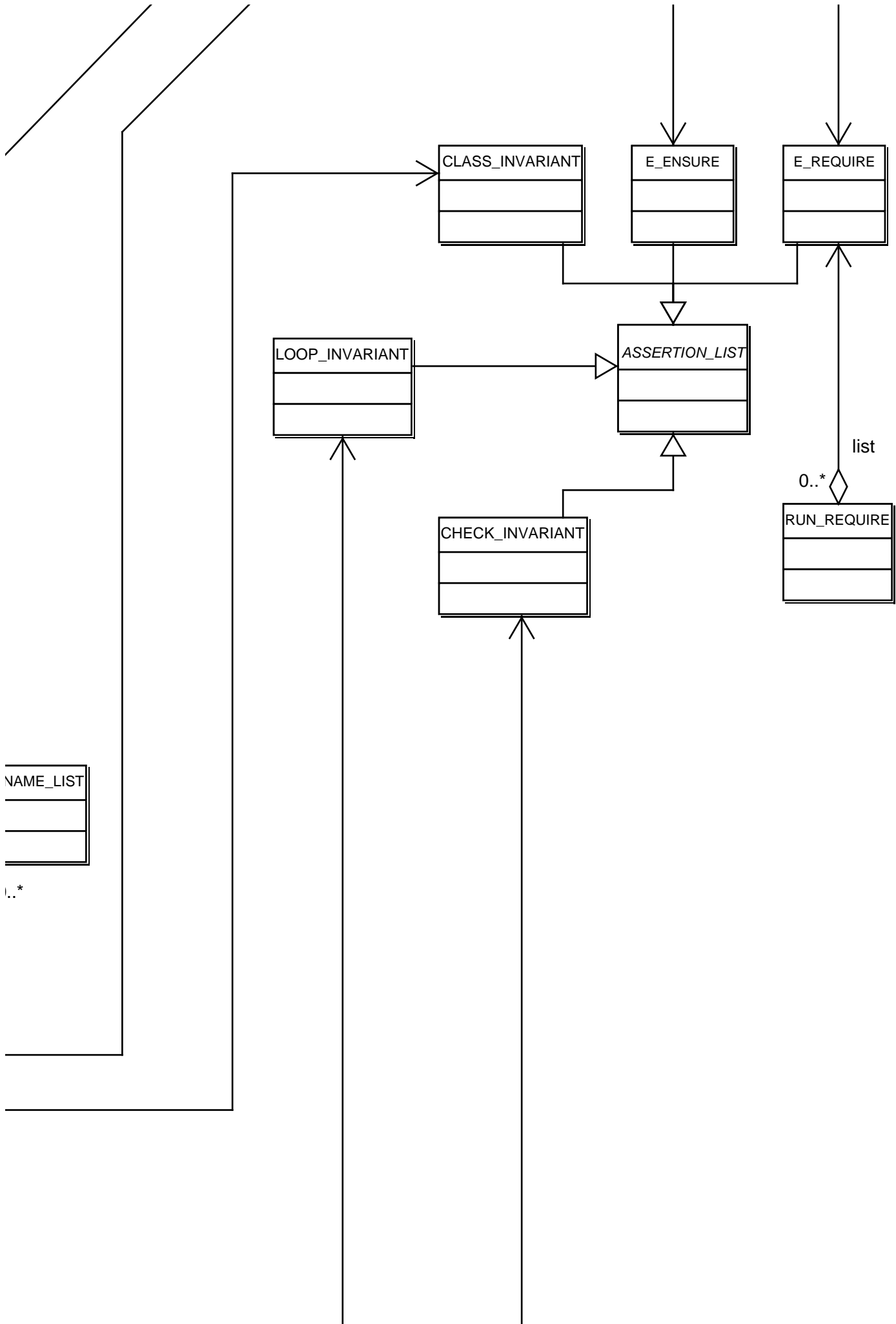

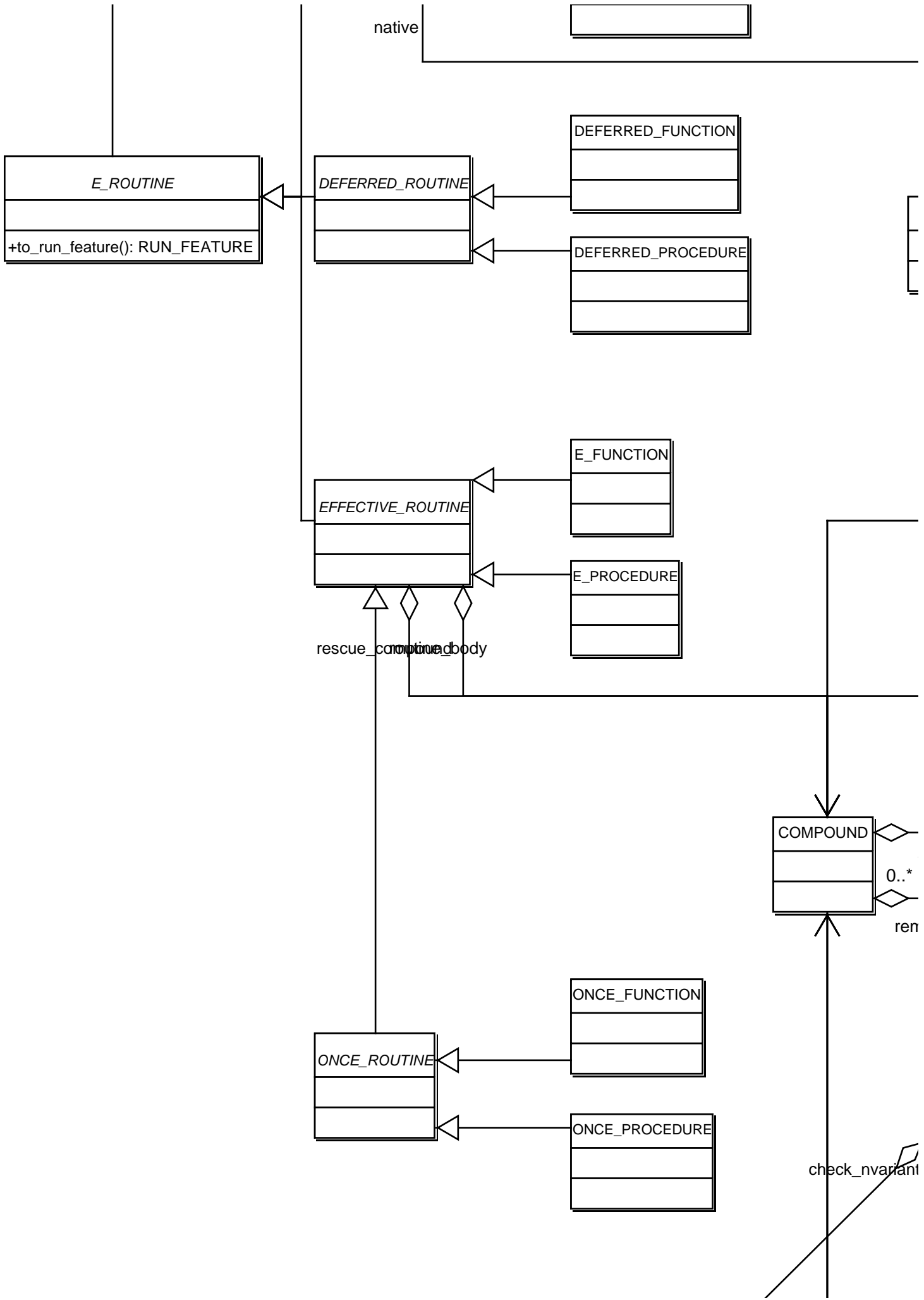

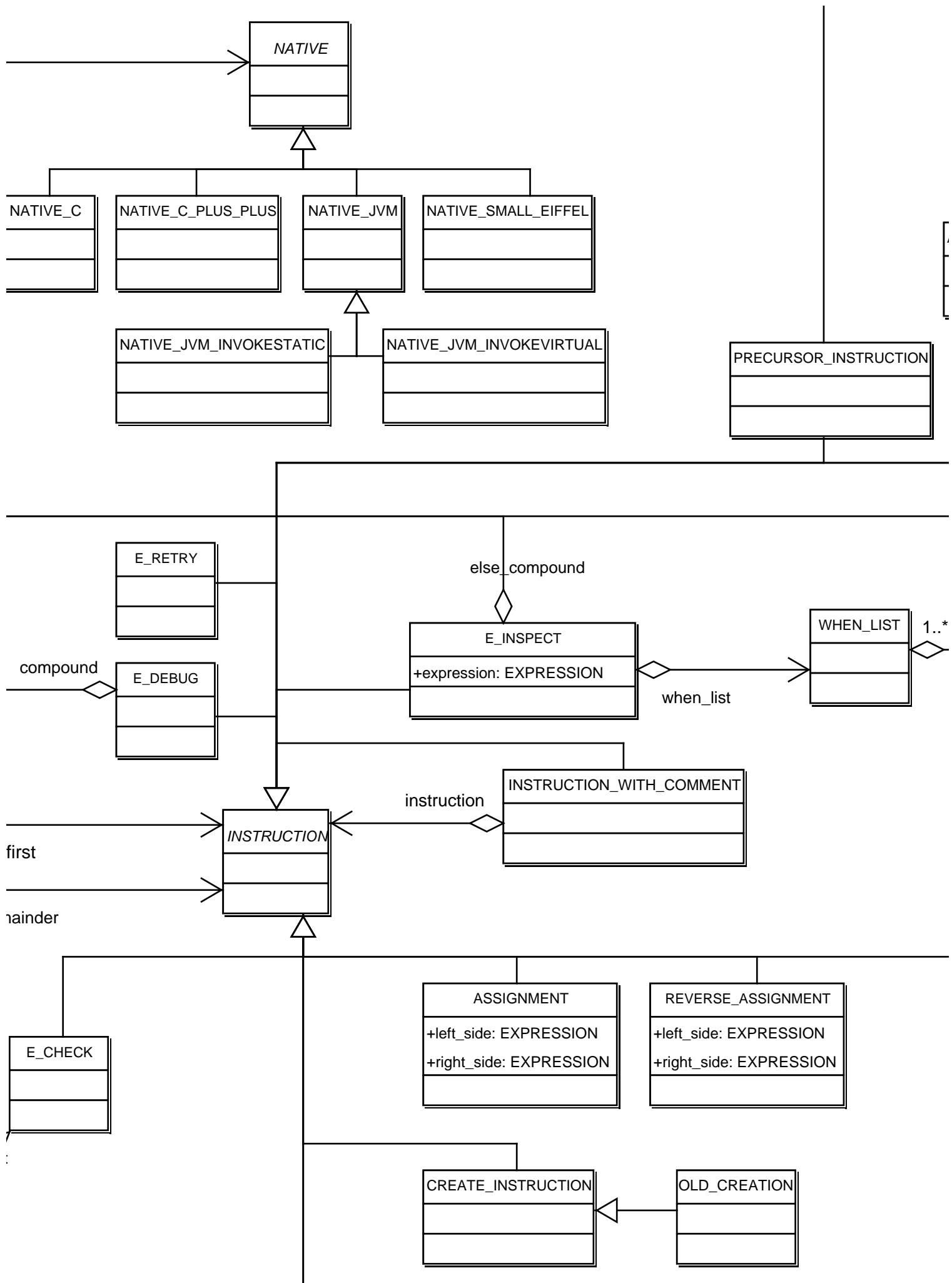

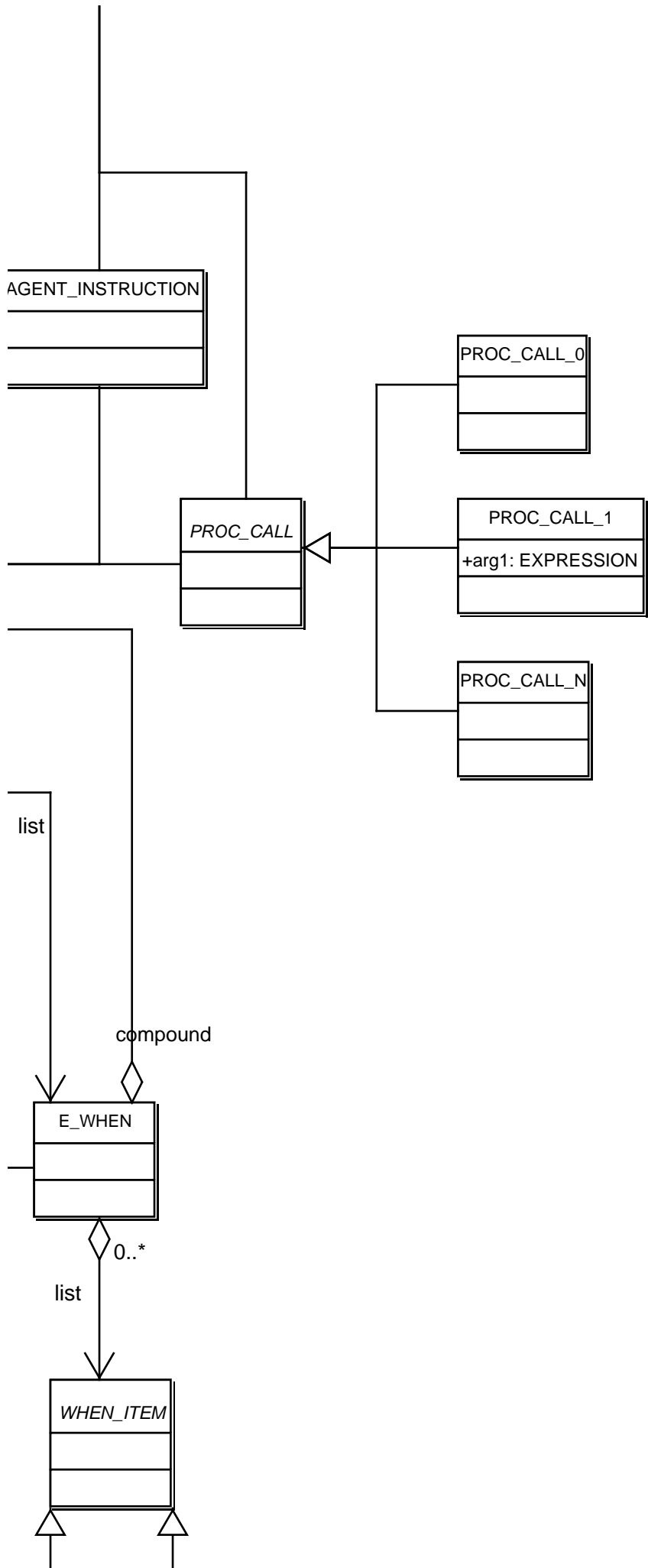

class diagram 1



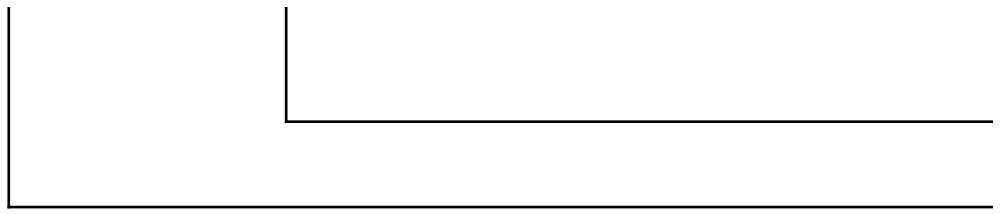

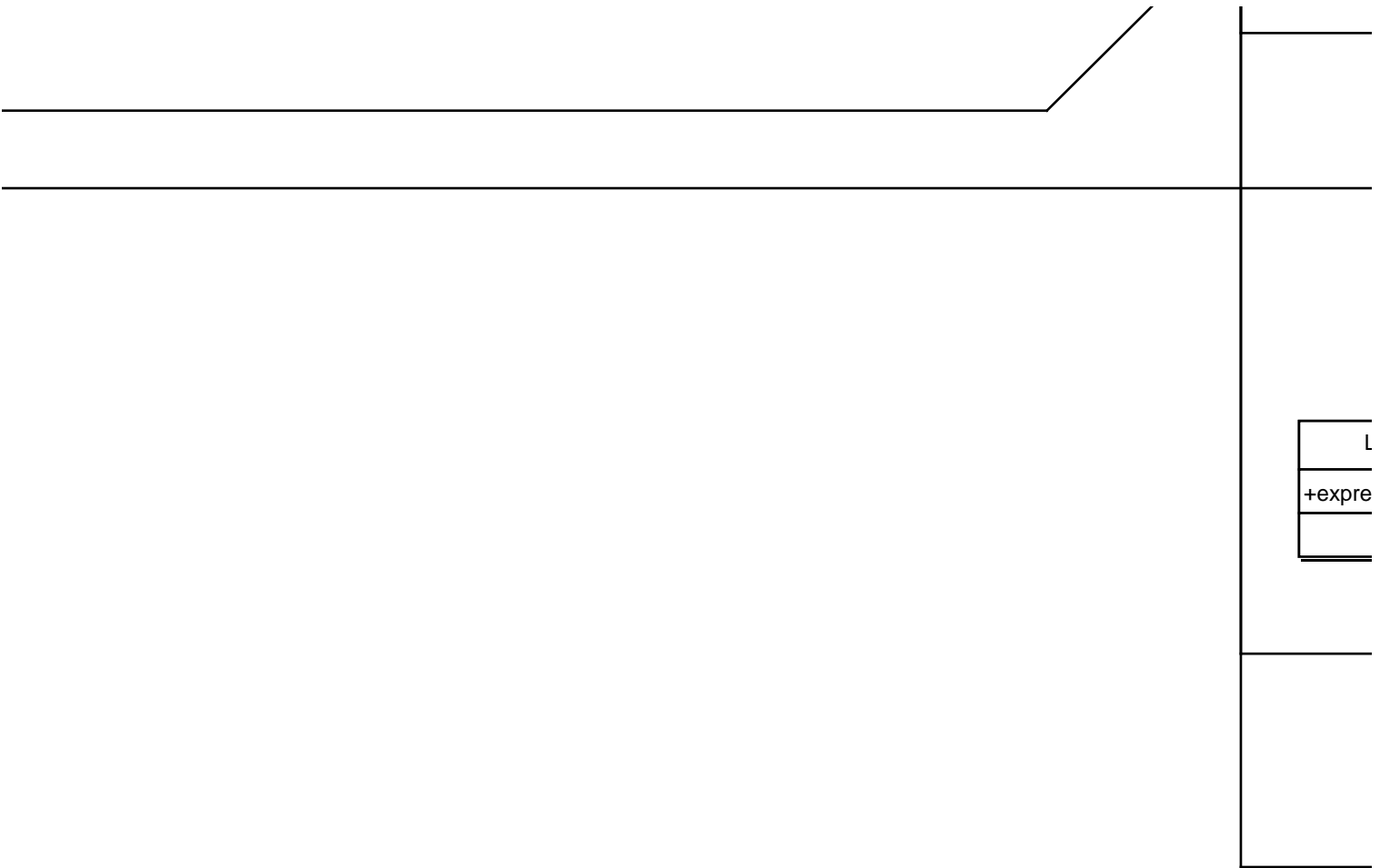

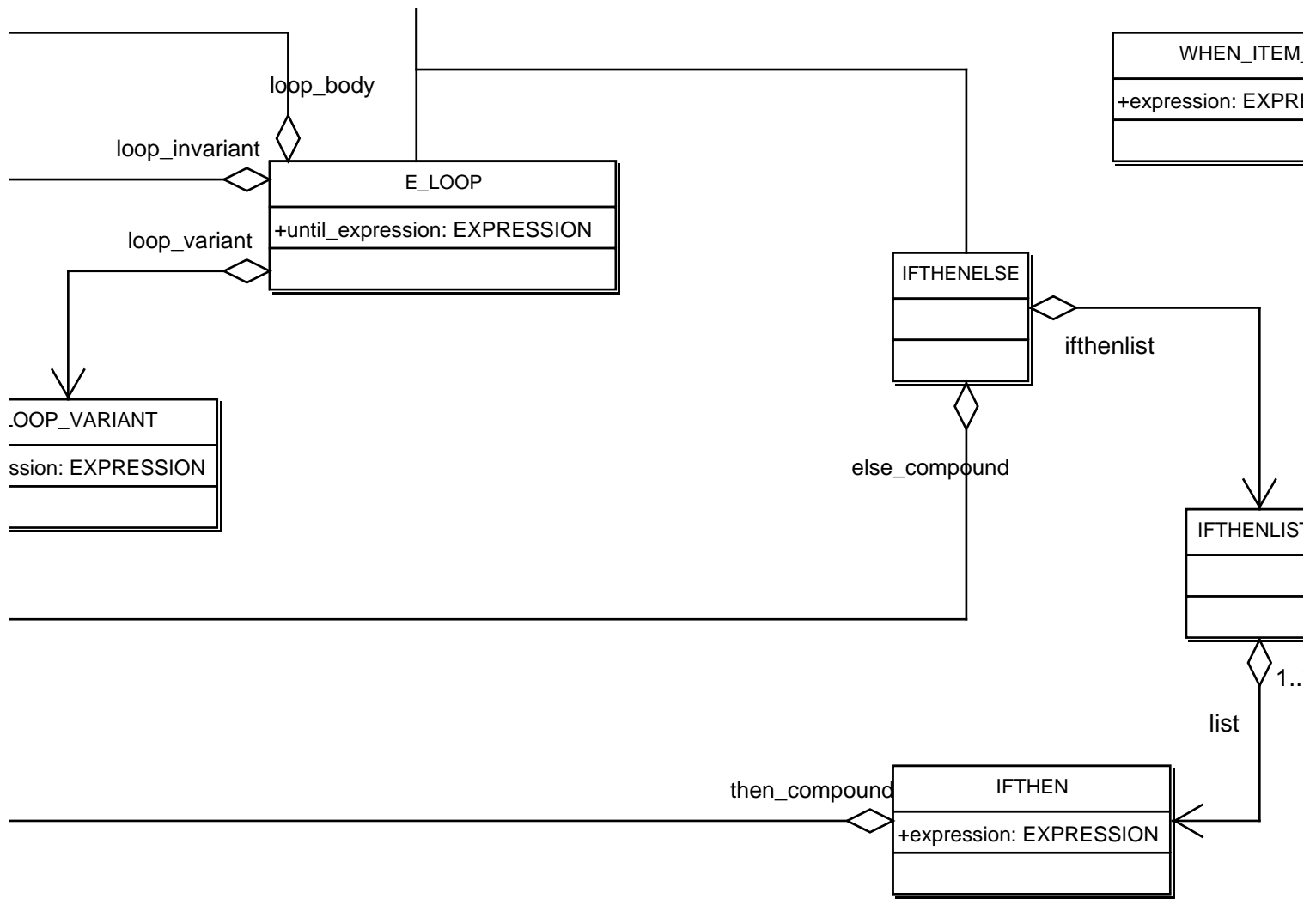

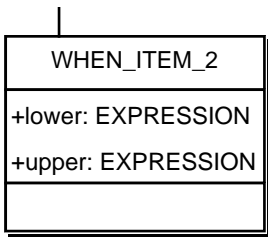
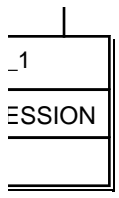

*